

STENSBALLE 

Rotorklipper type FH 2500 P
model 2008 - Transmission
tegnnet lk080707

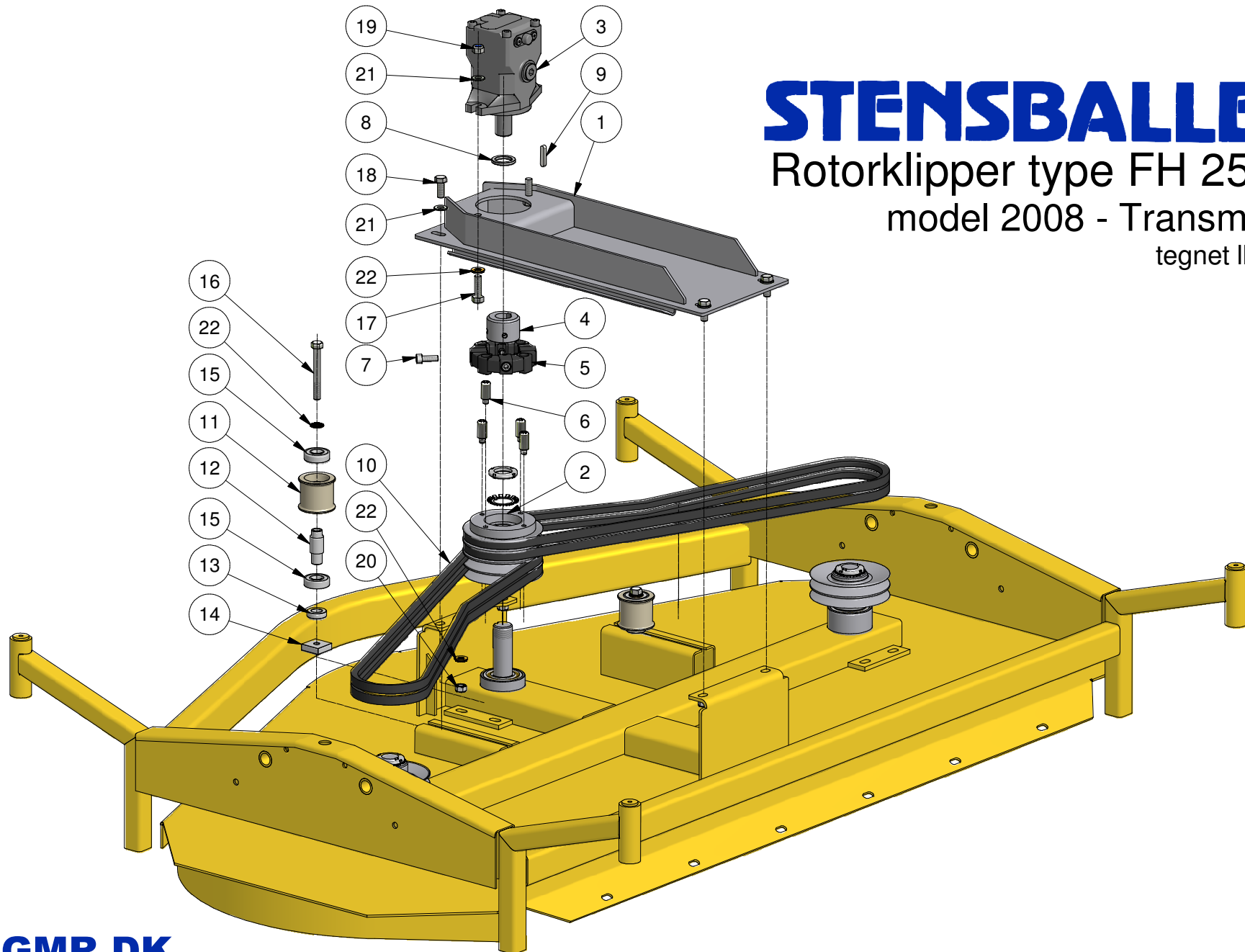

STENSBALLE

Rotorklipper type FH 2500 P

model 2008 - transmission

tegnet lk080707

<i>Pos.</i>	<i>Benævnelse</i>	<i>Antal</i>	<i>Nummer</i>	<i>Bemærkning</i>
1	Motorkonsol - SAE-B flange	1	77-805-110	
2	Medbringerremskive	1	77-804-620	B160/4
3	Hydraulikmotor	1	M4MF34-3-B4R85	
4	Koblingsnav	1	15-222-400	
5	Gummikobling	1	CFA012-0-S-60	
6	Stikbolt	4	CFA008-SB	
7	Rundhovedet unbracoskrue	4	32-110-030	
8	Afstandsring	1	210259-1	
9	Pasfeder A	4	34-108-740	
10	Kilerem	4	10-003-086	
11	Strammerulle	2	46-001-070	
12	Akseltap	2	46-401-070	
13	Fod	2	46-401-071	
14	Gevindstykke	2	46-301-060	
15	Kugleleje	4	54-026-204	
16	Maskinbolt	2	28-112-100	
17	Sætskrue	2	29-112-040	
18	Sætskrue	4	29-112-030	
19	Låsemøtrik	2	31-101-012	
20	Møtrik	4	31-001-012	
21	Facetskive	6	36-300-012	
22	Contact-skive	8	35-200-012	